

INSUL-FLUE®

OWNER'S MANUAL (6 inch)

*High Heat Resistant Thimble and Insulating Sleeve for
Smoke Pipe When Passing Through Any Combustible Wall*
October 2006, Revision B



INTRODUCTION

CONGRATULATIONS ON YOUR PURCHASE OF INSUL-FLUE®

INSUL-FLUE® is used to reduce the danger of radiant heat from smoke pipe, flue pipe, gas vents, etc. igniting combustibles.

A picture of the complete unit installed is on page 5, for Masonry Chimney or on page 7 for a Metal Chimney.

The product contains NO ASBESTOS or Formaldehyde.

Acquaint yourself with all parts of the INSUL-FLUE® during removal from the carton.

Contact local building or fire officials about restrictions and installation inspection in your area.

The UL & WH listing requires a minimum 2" air space clearance between insulated thimble and combustible material. The INSUL-FLUE® is designed to maintain this clearance by proper installation of the assembly. Proper installation also requires a **snug butt** contact of insulation parts, held **firmly** against the chimney by the INSUL-FLUE® Metal Base and Assembly hardware. (For Metal Chimneys see figures 10 & 11).

CAUTION: All clearances to combustibles (including wall, ceiling, corners, etc.) **must** be maintained as specified in your stove and or connector pipe installation instructions. Make sure that the smoke pipe pitch specified in the stove installation instructions is maintained.

On rare occasions, a wall may be too thick for the 8" length of Thimble which is sold separately from the INSUL-FLUE®. In such a situation, see page 4 for further instructions.



INSTALLATION INSTRUCTIONS FOR MODEL MC-6

1. After disassembling existing smoke pipe, place paper template with the 6" diameter circle (to be disposed of after use) perfectly over the hole from which the smoke pipe has been removed.

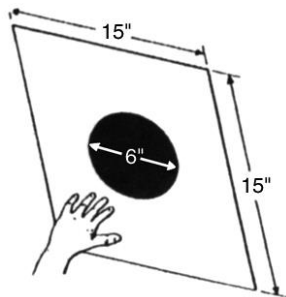

Figure 1: Template Placement

This template is designed to assist you in making the proper size opening of 15" square. Holding the template to the wall with one hand, mark around the edges that outline the new wall opening. (See Figure 1).

2. Saw along the marked lines to remove the 15" square piece of wall material. **CAUTION:** Make sure there are no electrical wires within the wall. The 15" square opening created must be kept completely free of combustibles. This means that if a wall stud or any other combustible material is encountered within the opening, it must be removed. If a wall stud is thus removed, it is recommended that in addition to cutting a section of wall stud out, appropriate framing or headers (as required) be installed. (See Figure 2)

This framing is required to provide an anchor for the INSUL-FLUE® Metal Base (17" square piece) and/or maintaining structural integrity. Be sure the frame you construct within the wall always maintains 15" of totally clear opening. This is to insure that there is two inches of free air space between any combustible and the outer surface of the INSUL-FLUE® Thimble.

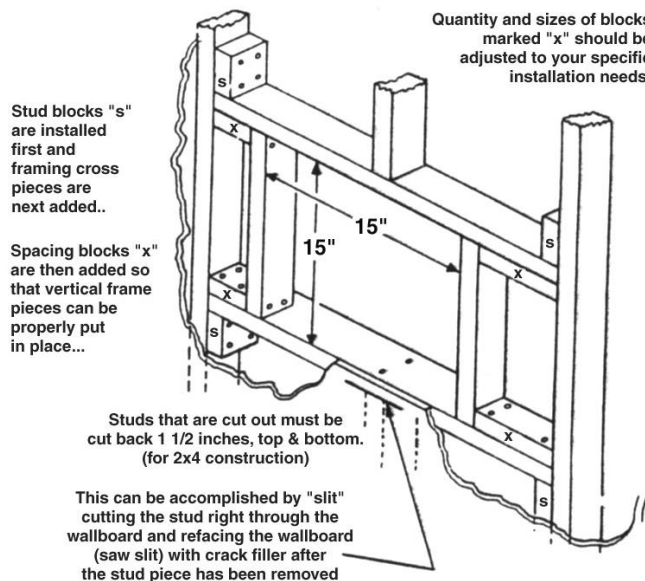

Figure 2: Framing and Header Suggestions

NOTE: If the INSUL-FLUE® is being installed into an exterior wall with an exterior masonry chimney, see Special Instructions (see Figure 9).

3. Mount the INSUL-FLUE® Metal Base (see Figure 3) on page 3 onto the wall using the eight longer screws supplied for this purpose. Plan the Metal Base positioning so that any smoke pipe pitch stated in the Stove installation instructions will be maintained.

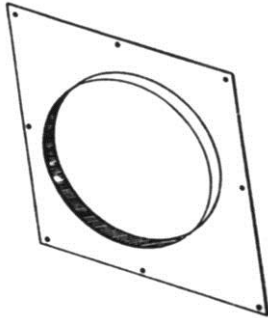

Figure 3: Metal Base Front

NOTE: The positioning flanges on the back side of the Metal Base (see Figure 4) are spaced to insure accurate positioning of the INSUL-FLUE® in the 15" opening and maintaining 2" of free air space on all sides.

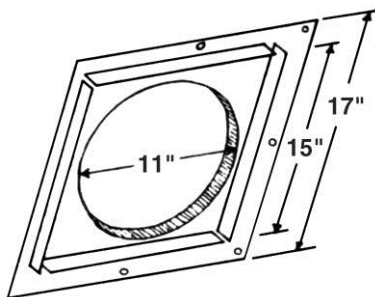

Figure 4: Backside of Metal Base

4. Insert the (thick wall) Thimble into the mounted Metal Base. Position Thimble firmly against chimney. The Thimble shall protrude at least 1/4 " beyond the Metal Base flange. If the Thimble protrudes more than 1/2" beyond round Metal Base flange (into room), mark Thimble using flange edge as a guide. (See Figure 5) Remove Thimble from Metal Base. Allow 1/4 " to 1/2 " additional length of Thimble beyond the marked line to protrude into the room. This additional length is your cutting line, and is **necessary** for the Thimble to be **firmly** held against the chimney. Using a handsaw, cut the excess portion of the thimble off. The use of a facemask is recommended as good practice while sawing Thimble.

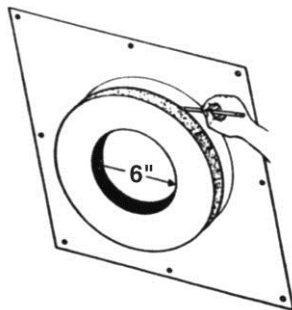

Figure 5: Thimble Length Adjustment

NOTE: If the 8" Thimble is not long enough to accommodate your wall, see page 4 for special instructions.

SPECIAL INSTRUCTIONS FOR USING LONGER OR DOUBLE THIMBLE

When a wall is too thick for the 8" length of Thimble, it is recommended you purchase a 12" Thimble or a combination of 8" and or 12" thimbles to accommodate any wall thickness. It is also required that you lay a bead of Rutland HI-Temp Stove Gasket Cement, on the inside end of the second Thimble to bump up against the outside end of the first Thimble. This will act as a sealant and an adhesive. (See Figure 6)

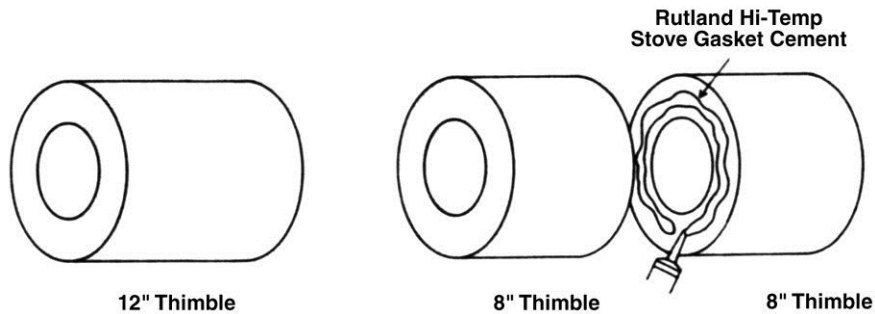

Figure 6: Thimble Extension

Lay a bead of cement, onto the end of the Thimble that butts against the masonry chimney. (See Figure 7) The cement will act as an adhesive and also seal the Thimble tightly to the masonry chimney should there be uneven surface. If the masonry chimney has a smooth surface the Cement will not be required. Reinsert the extended Thimble.

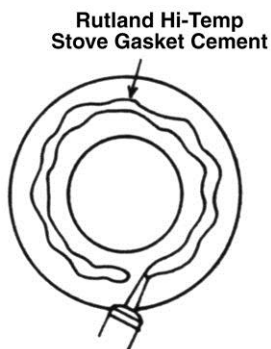

Figure 7: Applying Cement

5. Before final insertion of the Thimble, install one length of stainless steel smoke pipe making sure that the pipe is long enough so that there is no joint within the INSUL-FLUE®. Make sure that the stainless steel smoke pipe is inserted to the extent that its inner end is flush with the inner surface of the chimney liner. (See Figure 8)

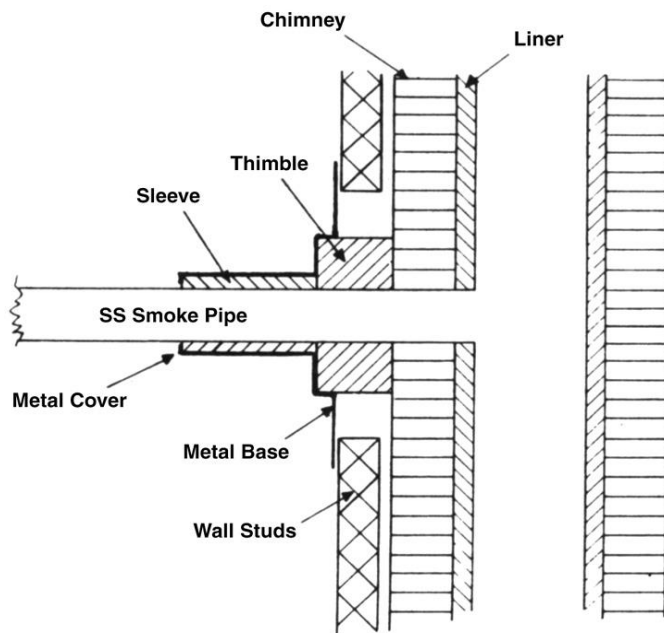

Figure 8: Wall Cross Section

6. The Sleeve is packed inside the Metal Cover as shipped. Install the Metal Cover/Sleeve by passing it over the smoke pipe and the protruding Thimble. Be sure the Metal Cover flange slides over the Metal Base flange.

NOTE: Position Metal Cover seam away from room view (seam away from view if mid-wall, seam at top if high on wall, seam at bottom if low on wall).

Care must be exercised by applying hand pressure such that the two flanges overlap as much as is possible. Using the four pre-drilled mounting holes in the Metal Cover flange as a guide, drill 1/16" or 3/32" matching holes in the Metal Base flange.

7. Using the four shorter screws provided, secure the Metal Cover/Sleeve to the Metal Base. When fastened, the entire assembly will be firmly held in position such that the Thimble is in contact with the chimney and the Sleeve is held against the Thimble. (See Figure 8)

8. Your new INSUL-FLUE® assembly is now completely installed. When necessary to remove the smoke pipe for cleaning purposes or inspection, it may be done without disassembly of any part of the INSUL-FLUE®.

9. A 2" air space must always be maintained. Never fill with insulation.

10. If in the event the INSUL-FLUE® is being installed into an exterior wall with an exterior masonry chimney and if you have any kind of space between the chimney and house it is important that this space be tightly enclosed. It is recommended that you purchase an Exterior Metal Enclosure. This is a metal frame that is installed just after you have made the framed hole in the wall (step 2) and before you mount the metal base onto the wall (step 3). The Exterior Metal Enclosure is made so that it can be secured to the wood frame of the house wall. As you insert the Exterior Metal Enclosure into position, make sure you slide it through the wall until it meets the exterior surface of the chimney. Then you secure it with nails to the wall. The holes have been predrilled in the exterior metal enclosure for your convenience. It is also recommended that you go on the outside of the house and caulk the points where the metal meets the chimney surface and also where the exterior house siding meets the metal. (See Figure 9)

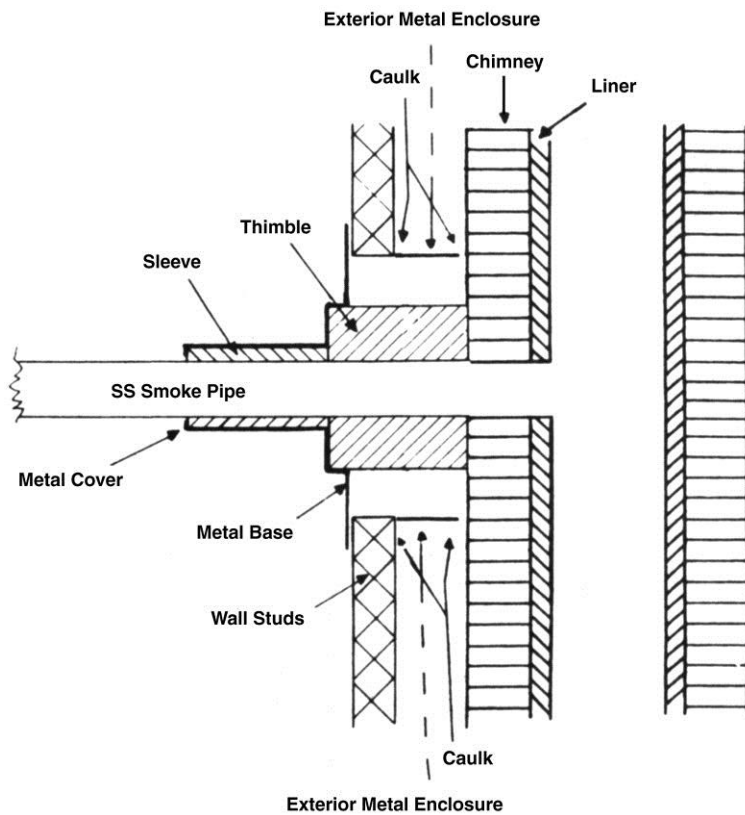
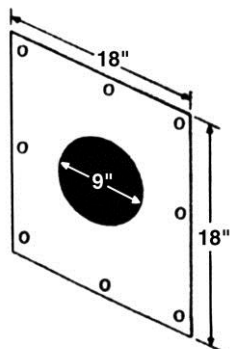

Figure 9: Exterior Metal Enclosure

In the event that the INSUL-FLUE® is being installed into an exterior wall to be connected to an exterior metal chimney, a Metal Adaptor Plate must be installed on the exterior part of the house wall. (See Figure 10 & 11)

An Anchor Plate is available from the metal chimney manufacturer and must be used to attach to the front of the Metal Adaptor Plate that will then connect to the Tee of the metal chimney.

The outside Metal Adaptor Plate must be used to protect the ceramic Thimble and all inside metal parts from the elements to prevent corrosion and so forth. If necessary, use caulk to maintain a weather-tight seal between house and Metal Adaptor Plate.



Metal Adaptor Plate

Figure: 10

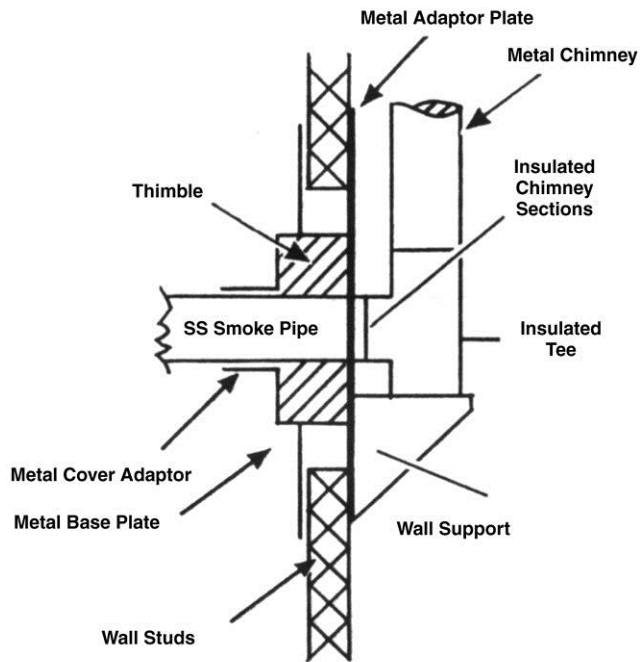

Figure 11: Wall Cross Section

OPERATING INSTRUCTIONS FOR MODEL MC-6

Your MC-6 INSUL-FLUE® as installed, has now become a part of your wood burning system. The operation of the wood burning system may cause creosote build up in the chimney connector (smoke pipe) and chimney.

"Creosote" - Formation and Need for Removal:

When wood is burned slowly, it produces tar and other organic vapors, which combine with expelled moisture to form creosote. The creosote vapors condense in a relatively cool chimney flue of a slow burning fire. As a result, creosote residue accumulates on the flue lining. When ignited this creosote makes an extremely hot fire.

The chimney connector and chimney should be inspected at least once every two weeks during the heating season to determine if a creosote buildup has occurred.

If creosote has accumulated it should be removed to reduce the risk of chimney fire."

After inspection or cleaning of wood burning system be sure your INSUL-FLUE® assembly is complete and secure as required in the installation instructions of this manual.

CAUTION: All combustibles including the wall, ceiling, stove parts, etc. must also be kept as specified in the Stove instructions. Make sure that the smoke pipe pitch specified in the Stove installation instructions will be maintained.

Inspect the connector frequently in the room into which the connector passes.

Do NOT place combustibles in the vicinity of this connector pipe. Never hang anything on the connector or drape anything over it. Be sure to maintain clearances to combustibles.